

# CWM-500

5" WATERPROOF MONITOR

## INSTRUCTION MANUAL

Thank you for purchasing this product.  
For proper usages and application,  
Please read this instruction manual thoroughly.

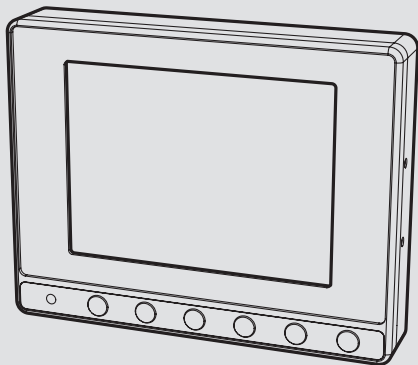



# CONTENTS

**SAFEGUARD INSTRUCTIONS** ..... 3

**FEATURE** ..... 5

**BOX CONTENTS** ..... 5

**FUNCTION OF EACH PART** ..... 6

**FUNCTION** ..... 7

**SETTING** ..... 9

**INSTALLATION and CONNECTION** ..... 11

**SPECIFICATION** ..... 13



## SAFEGUARD INSTRUCTIONS

5" WATERPROOF MONITOR

Please read the "Safety Rules" carefully before using this product. Following the safety rules prevents users from damages related with the misuse of the product. It is very important to follow these safety rules. We state "Caution" and "Warning" to clarify any potential risk for a damage associated with the misuse of the product.



**NOTICE**

This information is for user's reference for better usability.



**CAUTION**

This information is for preventing damage or shorten the life time of the products.



**WARNING**

This information is for preventing bodily harm or even death and use should follow this safety rules.



### CAUTION



Should install while power off. (After install products, connect DC jack)  
- It may cause to electronic shock or malfunction.



While stop driving (parking), set the car in motion.  
- It may cause battery discharge.



Do not use multi socket or extended adaptor.  
- It may cause unexpected heating, fire and malfunction.



Unplug product when do not use for a long time.  
- It may case fire by short circuit due to heating.















Do not place near magnet.  
- It may cause malfunction and trouble.



Before install the body, take enough place at least more than 15cm from the wall to emit heat.

## WARNING

-  Do not put the product in place where sudden temperature increasing and should use on optimum voltage, temperature and humidity.  
- It may cause to electronic shock or malfunction.
-  Do not place near of air bag effective range.  
- It may cause malfunction of air bag or accident, injury due to hitting monitor by air bag.
-  Keep clean dust on power socket.  
- It may cause electronic shock and fire by bad connection.
-  Do not pull cord with a jerk, should catch a plug and pull. Do not use damaged cord.  
- It may cause cord malfunction, electronic shock and fire.
-  When clean exterior, power off and wipe with dry cloth.  
- Wet cloth may cause a electronic shock.
-  Do not clean exterior with volatility or oily solvent.  
Neither keep touching rubber and plastic for long time.  
- It may cause change of surface, fall of paint, malfunction and fire.
-  Do not place where vibration and shock.  
- It may cause throw down and then malfunction and accident.
-  Do not put a pin or needle on the hole or crack in the body.  
- In case of inserting them, stop to operate, it may cause electronic shock, fire and malfunction.
-  Do not use in problem condition as like smoking, smell something burn.  
- It may cause fire. Stop to use and make inquiries to agency.
-  Do not disassemble, repair and remodeling.  
- It may cause malfunction and injury, can not get warranty.  
- Make inquiries to agent for repair and checkup.
-  When the power cable cord touches a metal case, cover it with a friction tape.  
- Short circuit or disconnection of wire may cause a fire or accident.
-  Do not use bolts or nuts from a parts for vehicle.  
- Using bolt or nuts from steering column or break may cause an accident.
-  After installing, check it break lamp, head lamp and wipe works properly.

## 1 FEATURE

5" WATERPROOF MONITOR

- Water Resistant (IP-67), Aluminum housing
- Application of TFT LCD with high resolution and low reflection
- All functions are displayed on screen (OSD function)
- PWM volume control
- Mode selection function (3 Mode)
- Low energy consuming rate
- Language Display Selection (ENG-DEU-ITA-FRA-SPA-KOR-JPN)
- Free voltage (From DC 12V to DC24V)

## 2 BOX CONTENTS

5" WATERPROOF MONITOR

- Before use this products, please check below contents. If there is something missing parts, please contact sales agent.

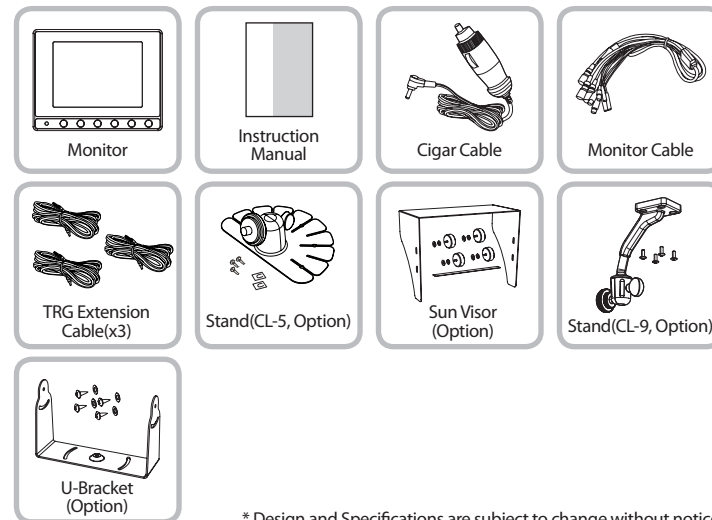

\* Design and Specifications are subject to change without notice.

# 3

## FUNCTION OF EACH PART

5" WATERPROOF MONITOR

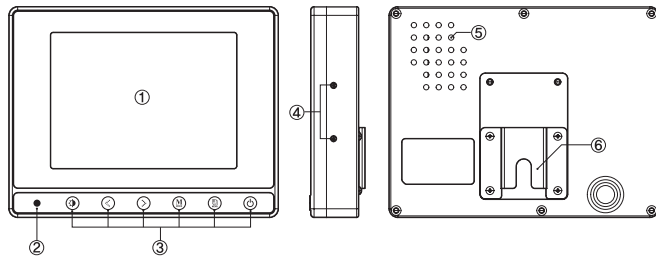

1. LCD SCREEN	QVGA (320x234)
2. STAND BY LED	Stand by lamp
3. BUTTONS	DIMMER, LEFT, RIGHT, MODE, MENU, POWER
4. SUN VISOR HOLE	Sun Visor installation hole
5. SPEAKER HOLE	Speaker hole (Waterproof)
6. STAND BRACKET	Stand fix Bracket

# 4

## FUNCTIONS

5" WATERPROOF MONITOR

### 1 POWER ON / OFF

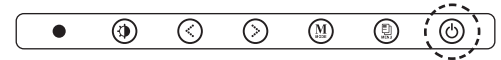

1. Press POWER button for power ON. (Stand-by LED is OFF)
2. Press POWER button again for power OFF. (Stand-by LED is ON)

### 2 MODE

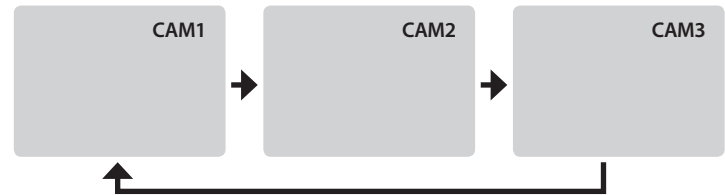

1. Press MODE button.
2. CAM1 - CAM2 - CAM3 - CAM1 appears on the screen.
3. it is disappeared after 3 sec.

### 3 VOLUME CONTROL

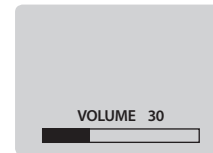

1. Press LEFT/RIGHT button.
2. The monitor shows volume on the screen and volume is UP/DOWN. (0~100)

### 4 DIMMER

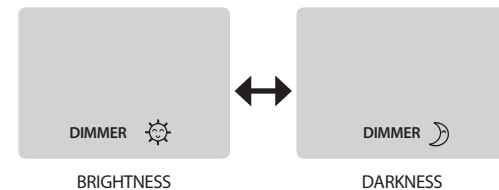
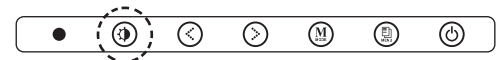

# 5

## SETTING

5" WATERPROOF MONITOR

### 5 Screen switch while trigger input

What is <Trigger input> or <Trigger signal>? We call it when a circuit works by a signal for example if driver uses right/left turn signal or reverse gear, the monitor shows connected camera screen on driving mode.

\* Below example is set with TRG1(Left signal light)=CAM1 / TRG2(Right signal light)=CAM2 / TRG3(Rear light)=CAM3.

1) If there is trigger signal input, the connected screen (Trigger input screen) is displayed and the screen goes former one when the signal is disappeared.



2) In case of light on emergency blinker(TRG1+TRG2), the monitor displays CAM3. And the screen goes former one when the signal(light on emergency blinker) is disappeared.

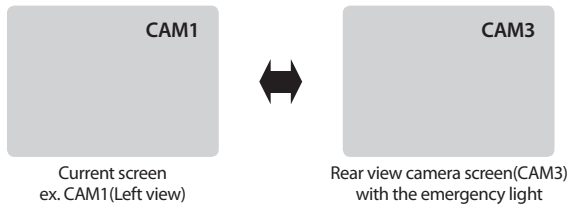

**The example is set with TRG1(Left signal light)=CAM1 / TRG2(Right signal light)=CAM2 / TRG3(Rear light)=CAM3.**

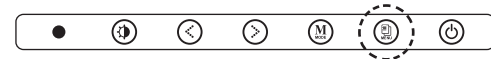

1. Use MENU button to change MAIN MENU (SETUP - PICTURE - CAMERA)



2. Use MODE button to select SUB MENU and then use LEFT/RIGHT button to adjust.

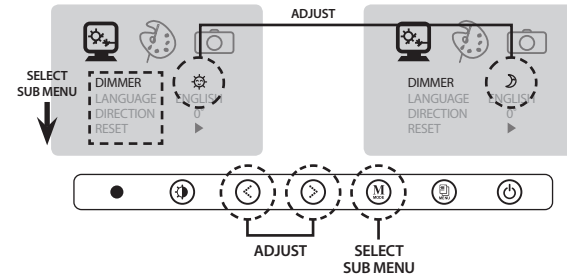

### SETUP

- DIMMER



- LANGUAGE



- DIRECTION

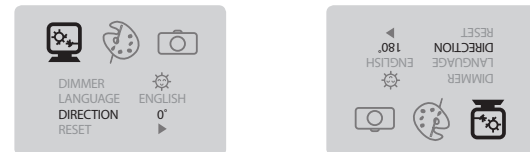

- RESET : Reset will have the monitor with the factory default value.

# 6

## INSTALLATION and CONNECTION

5" WATERPROOF MONITOR

### PICTURE



1. Use MODE button to select CONTRAST, BRIGHTNESS, COLOR, TINT menu.  
(Selected menu is in red.)

2. Press LEFT/RIGHT button to adjust the number.

### CAMERA

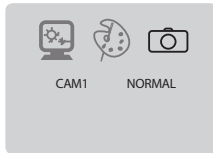

CAM1 NORMAL

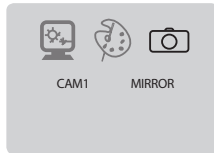

CAM1 MIRROR

Connected camera NORMAL / MIRROR selecting function  
In CAM2(or CAM3) Mode, CAM2(or CAM3) NORMAL/MIRROR is adjusted.

### INSTALLATION

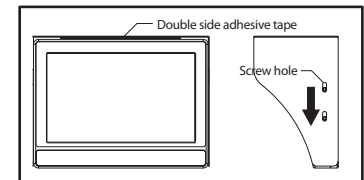
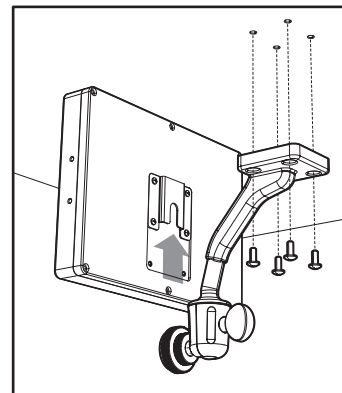
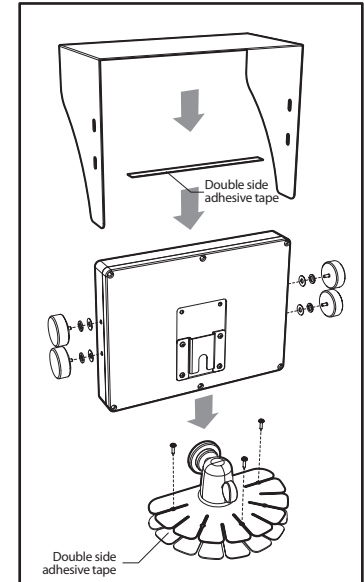
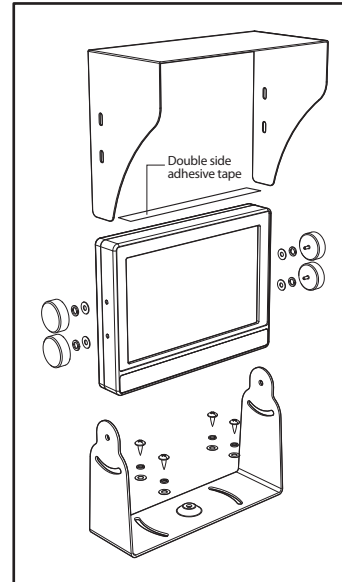

Sun Visor should be installed with 4 screws.

## CONNECTION

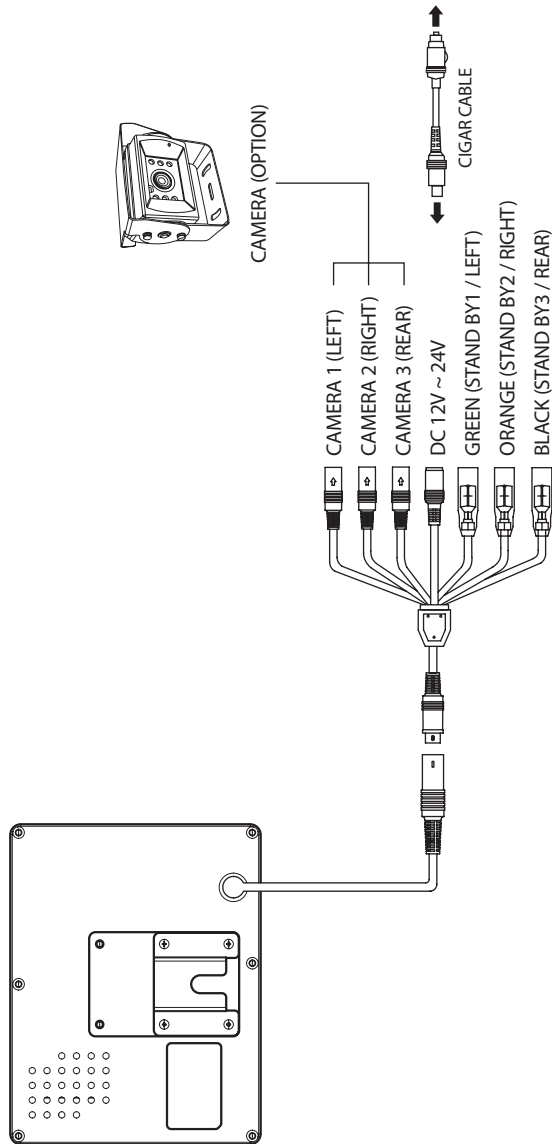

## 7 SPECIFICATION

5" WATERPROOF MONITOR

LCD Panel	Screen size	5 inch
	Resolution	QVGA (320x234)
	Brightness	400cd/m <sup>2</sup>
	Contrast ratio	400:1
Power Supply	View angle(L/R/U/D)	70° / 70° / 40° / 60°
	Voltage	DC 12V ~ 24V
Input System		NTSC / PAL
Frequency	NTSC	H: 15.734 kHz / V: 60 Hz
	PAL	H: 15.625 kHz / V: 50 Hz
Input Signal	Video Signal	Composite Video 1Vp-p (75 ohm)
	Audio Signal	MONO INPUT 400 mVrms
Speaker		0.5 Watt max.
Language display selection		7 languages
Operating temperature		-10°C ~ 60°C
Storage temperature		-20°C ~ 70°C
Dimension		152(W) x 119(H) x 27(D) mm (Monitor Only)
Weight		620g (Monitor only)



NOTICE

In case of starting usage on low temperature than working temperature, the screen may blink for a while (2~5 minute). Please wait about 10 minutes and try to power on again.



**MEMO**

---

A large, empty rectangular area with rounded corners, outlined in a thin gray border, intended for writing a memo.



**MEMO**

---

A large, empty rectangular area with rounded corners, outlined in a thin gray border, intended for writing a memo.



# INSTRUCTION MANUAL