

CWM-700

7" WATERPROOF MONITOR

INSTRUCTION MANUAL

Thank you for purchasing this product.
For proper usages and application,
Please rear this instruction manual thoroughly.

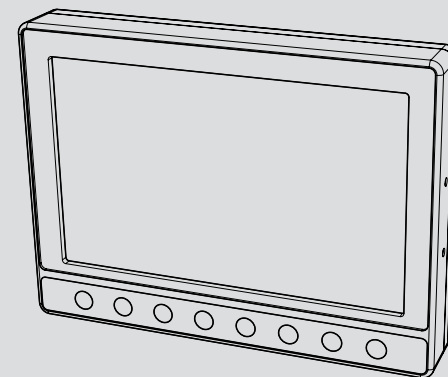

INSTRUCTION MANUAL



CONTENTS

SAFEGUARD INSTRUCTIONS	3
FEATURE	5
CONTENTS	5
FUNCTION OF EACH PART	6
FUNCTION	7
SETTING	14
CONNECTING AND INSTALLATION	16
SPECIFICATION	18



SAFEGUARD INSTRUCTIONS

7" WATERPROOF MONITOR

Please read the "Safety Rules" carefully before using this product. Following the safety rules prevents users from damages related with the misuse of the product. It is very important to follow these safety rules. We state "Caution" and "Warning" to clarify any potential risk for a damage associated with the misuse of the product.



NOTICE

This information is for user's reference for better usability.



CAUTION

This information is for preventing damage or shorten the life time of the products.



WARNING

This information is for preventing bodily harm or even death and use should follow this safety rules.



CAUTION



Should install while power off. (After install products, connect DC jack)
- It may cause to electronic shock or malfunction.



While stop driving (parking), set the car in motion.
- It may cause battery discharge.



Do not use multi socket or extended adaptor.
- It may cause unexpected heating, fire and malfunction.



Unplug product when do not use for a long time.
- It may case fire by short circuit due to heating.





Do not place near magnet.
- It may cause malfunction and trouble.



Before install the body, take enough place at least more than 15cm from the wall to emit heat.

WARNING

-  Do not put the product in place where sudden temperature increasing and should use on optimum voltage, temperature and humidity.
 - It may cause to electronic shock or malfunction.
-  Do not place near of air bag effective range.
 - It may cause malfunction of air bag or accident, injury due to hitting monitor by air bag.
-  Keep clean dust on power socket.
 - It may cause electronic shock and fire by bad connection.
-  Do not pull cord with a jerk, should catch a plug and pull. Do not use damaged cord.
 - It may cause cord malfunction, electronic shock and fire.
-  When clean exterior, power off and wipe with dry cloth.
 - Wet cloth may cause a electronic shock.
-  Do not clean exterior with volatility or oily solvent. Neither keep touching rubber and plastic for long time.
 - It may cause change of surface, fall of paint, malfunction and fire.
-  Do not place where vibration and shock.
 - It may cause throw down and then malfunction and accident.
-  Do not put a pin or needle on the hole or crack in the body.
 - In case of inserting them, stop to operate, it may cause electronic shock, fire and malfunction.
-  Do not use in problem condition as like smoking, smell something burn.
 - It may cause fire. Stop to use and make inquiries to agency.
-  Do not disassemble, repair and remodeling.
 - It may cause malfunction and injury, can not get warranty.
 - Make inquiries to agent for repair and checkup.
-  When the power cable cord touches a metal case, cover it with a friction tape.
 - Short circuit or disconnection of wire may cause a fire or accident.
-  Do not use bolts or nuts from a parts for vehicle.
 - Using bolt or nuts from steering column or break may cause an accident.
-  After installing, check it break lamp, head lamp and wipe works properly.

1 FEATURE

7" WATERPROOF MONITOR

- Water Resistant (Aluminum housing)
- 4 Camera input (NTSC/PAL)
- 2, 3, 4 Split screen function
- Dimmer sensor built in
- 7inch WVGA(800x480) WIDE LCD Panel

2 CONTENTS

7" WATERPROOF MONITOR

- Before use this products, please check below contents. If there is something missing parts, please contact sales agent.

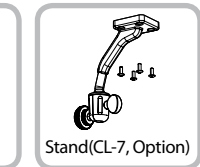
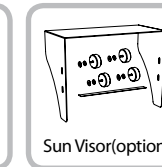
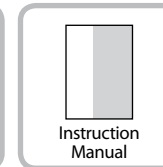
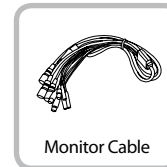
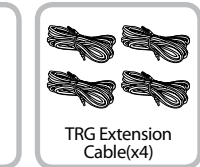
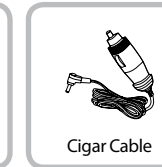
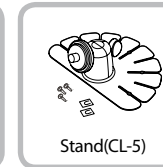
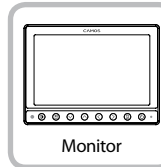

* Design and Specifications are subject to change without notice.

3

FUNCTION OF EACH PART

7" WATERPROOF MONITOR

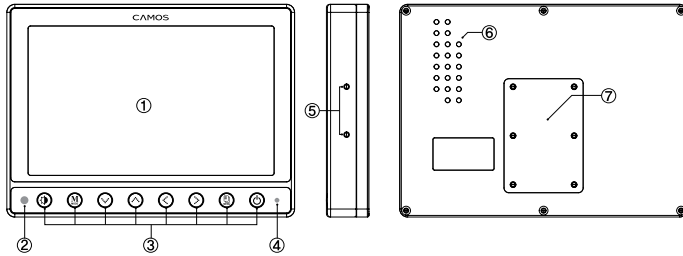

1. LCD SCREEN	WVGA (800x480)
2. DIMMER SENSOR	Automatic brightness control sensor
3. BUTTONS	DIMMER, MODE, UP/DOWN/LEFT/RIGHT, MENU, POWER
4. STAND BY LED	Stand by lamp
5. SUN VISOR HOLE	Sun Visor installation hole
6. SPEAKER HOLE	Speaker hole (Waterproof)
7. STAND HOLE	Stand fix hole

4

FUNCTION

7" WATERPROOF MONITOR

1 POWER ON/OFF

Press [] button to the power.
Press [] button again to off.

*** If there is no video input, then the camera will be shown Black.**

*** The screen is set 4 split from the factory.**

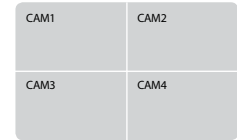

2 VOLUME CONTROL

Press [< >] button to control volume(0~100).

In CAM3 screen, the volume control works.

*** Volume is set 30 from the factory.**



3 SCREEN SWITCH

Press [] button to switch Full screen -> 2 split screen -> 3 split screen -> 4 split screen -> Full screen.

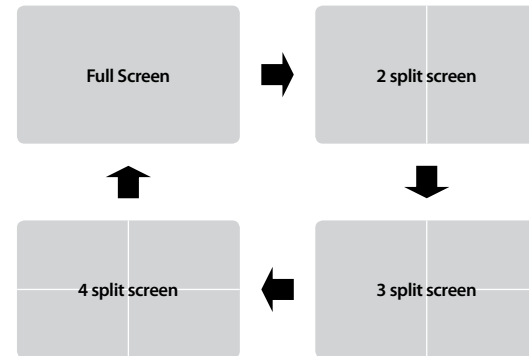

4) 2, 3, 4 SPLIT SCREEN SWITCH

In the split screen, press [↔] button to see the different split like below.

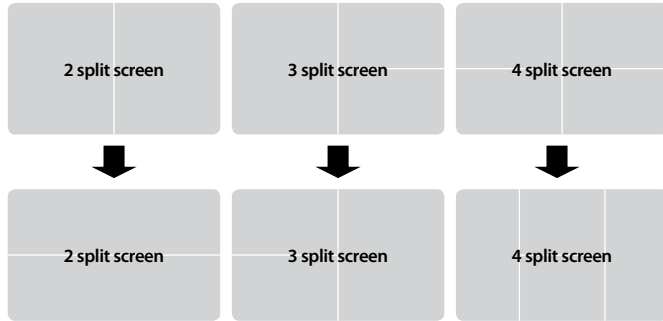

5) CAMERA SELECTION

1) In the FULL SCREEN

In the full screen, press [↔] button to see CAM1 → CAM2 → CAM3 → CAM4 → CAM1.

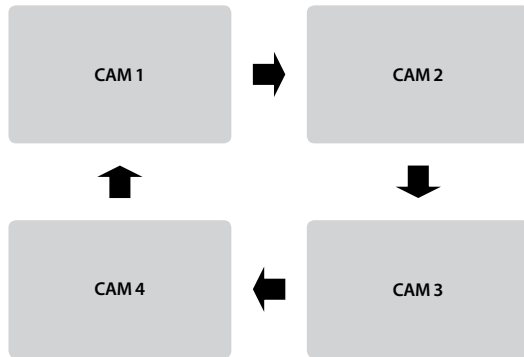

Press [↔] button, then it displays screen information (Input mode / Volume).

2) In the 2 split screen

In the 2 split screen, press [MENU] button to see the OSD. In the OSD, using with [↔] button the camera position (Left or Right) could be selected. Then press [↔] button to select the camera.

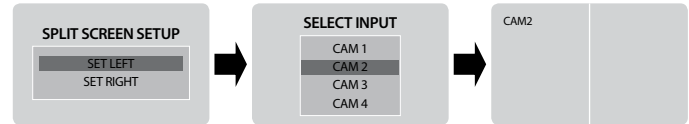

3) In the 3 split screen

In the 3 split screen, press [MENU] button to see the OSD. In the OSD, using with [↔] button the camera position (Left, Top or Bottom) could be selected. Then press [↔] button to select the camera.

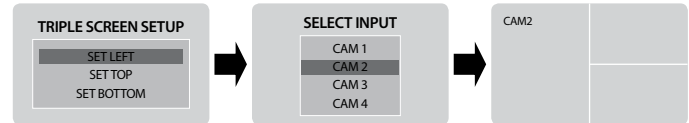

4) In the 4 split screen

In the 4 split screen, press [MENU] button to see the OSD. In the OSD, using with [↔] button the camera position (Top left, Top right, Bottom left or Bottom right) could be selected. Then press [↔] button to select the camera.

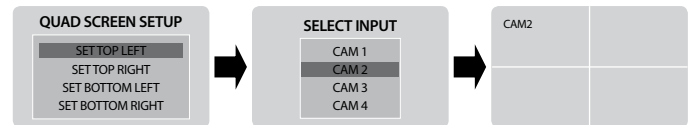

6 Normal / Mirror view switch

1) CAM1 or CAM2 full screen

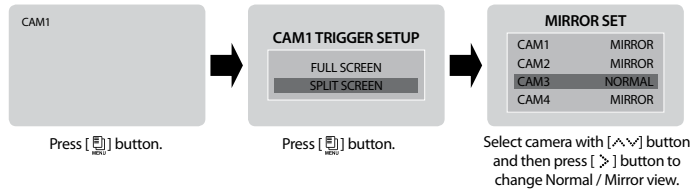

2) CAM3 or CAM4 full screen

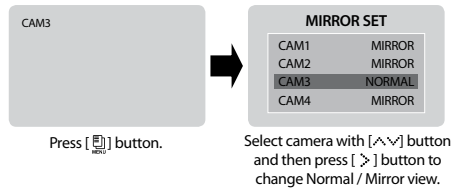

3) Split screen (2/3/4)

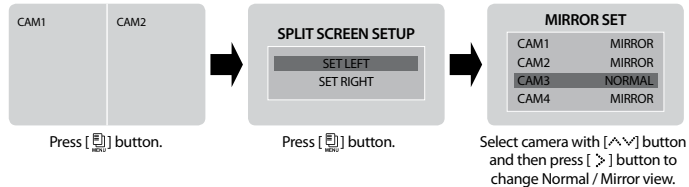

7 Screen switch while trigger input

What is <Trigger input> or <Trigger signal>? We call it when a circuit works by a signal for example if driver uses right/left turn signal or reverse gear, the monitor shows connected camera screen on driving mode.

* **Below example is set with TRG1(Left signal light)=CAM1 / TRG2(Right signal light)=CAM2 / TRG3(Rear light)=CAM3 / TRG4(etc.)=CAM4.**

1) If there is trigger signal input, the connected screen (Trigger input screen) is display as full screen and the screen goes former one when the signal is disappear.

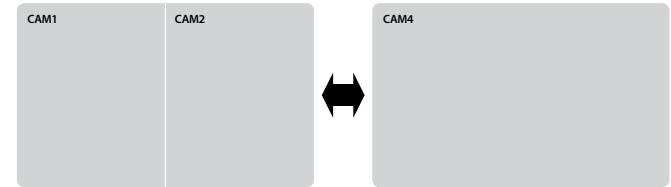

2) In case of TRG1 and TRG2 input, by the OSD, the full or split screen could be selected. If there is the TRG1(2) signal input, then CAM1(CAM2) and CAM3 split screen are shown on the screen. with this function, Left(Right) and Rear side could be checked.

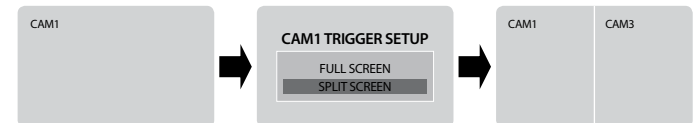

In CAM1 full screen, press [] button to see OSD. Select split screen with [] button and then press [] button. If there is the left signal input(TRG1), then CAM1(Left) in left side and CAM3(Rear) in right side will be shown on the screen.

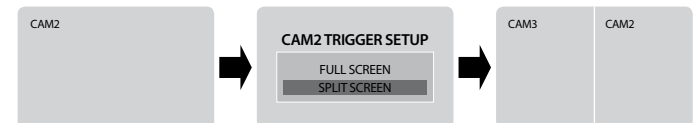

In CAM2 full screen, press [] button to see OSD. Select split screen with [] button and then press [] button. If there is the left signal input(TRG1), then CAM3(Rear) in left side and CAM2(Right) in right side will be shown on the screen.

3) When there is the TRG3(Rear light) input, CAM3 video will be shown on the screen. with [↕] button, the 2 split screen CAM1/CAM3 or CAM3/CAM2 could be displayed.

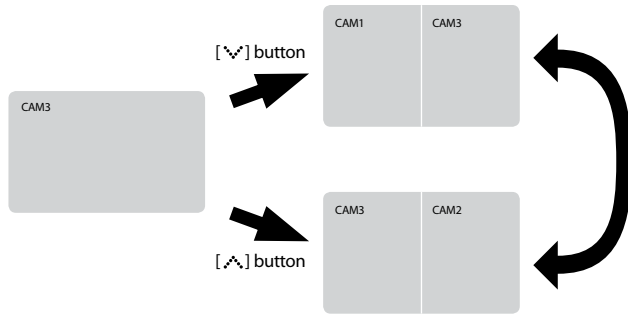

4) In case of light on emergency blinker(TRG1+TRG2), the monitor display CAM1~CAM4 as quad split screen. And the screen goes former one when the signal(light on emergency blinker) is disappeared.

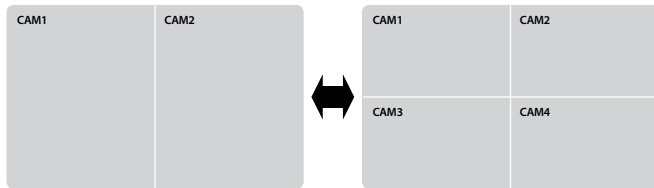

The example is set with TRG1(Left signal light)=CAM1 / TRG2(Right signal light)=CAM2 / TRG3(Rear light)=CAM3 / TRG4(etc)=CAM4.

5) When there is input signal more than 2 triggers, the monitor display fully connected screen (Trigger input screen) as the priority order. And the screen goes former one when the signal is disappears, the rest will be display as the priority order.



TRIGGER PRIORITY ORDER
 TRG3(Rear light) > TRG1+2(Emergency light) > TRG1(Left side light) > TRG2(Right side light) > TRG4

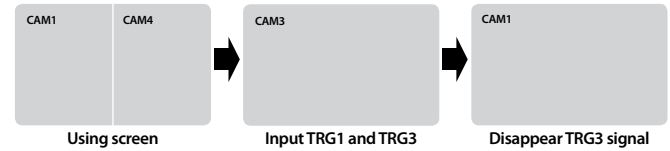





- * If the screen turns by trigger signal, [M] button doesn't work.
- * If trigger signal inputs while power off(Stand-by) status, the screen power on and display connected screen. And the screens turns off when the trigger signal is disappeared.

5 SETTING

7" WATERPROOF MONITOR

1 Video standard system, NTSC / PAL conversion

PICTURE SETUP	
DIMMER	DAY
CONTRAST	50
BRIGHTNESS	50
COLOR	50
TINT	50
LANGUAGE	ENGLISH
VIDEO SYSTEM	NTSC
RESET	>

- 1) Press [] button until OSD menu [PICTURE SETUP] appears.
- 2) Press [ ] button to move a place where want to change and choice proper value by pressing [ ] button.

If use PAL system on NTSC system using country, it may cause a malfunction. This products can convert NTSC / PAL system manually but it is not automatic. Before use, Please check and set the system.







NOTICE

NTSC system country : USA, CANADA, JAPAN, KOREA, TAIWAN, MEXICO, etc.
PAL system country : AUSTRALIA, GERMANY, U.K, NETHERLAND, ITALY, etc.

2 Dimmer sensor setting

PICTURE SETUP	
DIMMER	DAY
CONTRAST	50
BRIGHTNESS	50
COLOR	50
TINT	50
LANGUAGE	ENGLISH
VIDEO SYSTEM	NTSC
RESET	>





- 1) Press [] button until OSD menu [PICTURE SETUP] appears.
- 2) Press [ ] button to move a place where want to change and choice proper value, DAY(brighter) / NIGHT(Darker) / AUTO(Sensor) by pressing [ ] button.

Press [] button to switch DAY → NIGHT → AUTO → DAY.

* Dimmer is set AUTO from the factory.

3 Picture setup





PICTURE SETUP	
DIMMER	DAY
CONTRAST	50
BRIGHTNESS	50
COLOR	50
TINT	50
LANGUAGE	ENGLISH
VIDEO SYSTEM	NTSC
RESET	>

- 1) Press [] button until OSD menu [PICTURE SETUP] appears.
- 2) Press [ ] button to move a place where want to change from BRIGHT to SATURATION and choice proper value by pressing [ ] button.

* Each setting value is set 50 from the factory.

4 Language display selection

PICTURE SETUP	
DIMMER	DAY
CONTRAST	50
BRIGHTNESS	50
COLOR	50
TINT	50
LANGUAGE	ENGLISH
VIDEO SYSTEM	NTSC
RESET	>





- 1) Press [] button until OSD menu [PICTURE SETUP] appears.
- 2) Press [ ] button to move a place where want to change and choice proper value by pressing [ ] button.

* This will let the product have.

* language selection : ENGLISH - FRENCH - GERMAN - ITALIAN - SPANISH

5 Reset

PICTURE SETUP	
DIMMER	DAY
CONTRAST	50
BRIGHTNESS	50
COLOR	50
TINT	50
LANGUAGE	ENGLISH
VIDEO SYSTEM	NTSC
RESET	>

- 1) Press [] button until OSD menu [PICTURE SETUP] appears.
- 2) Press [ ] button to move to RESET and then press [ ] button.

* This will let the product have.

6

CONNECTING AND INSTALLATION

7" WATERPROOF MONITOR

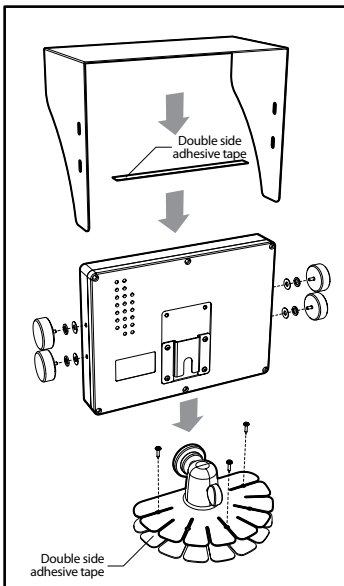

1. Before installation, place the product on enough space to radiate a heat easily. Install the monitor stand with enclosed screws and double side adhesive tape as the picture.

2. Fix the monitor to the monitor stand firmly.

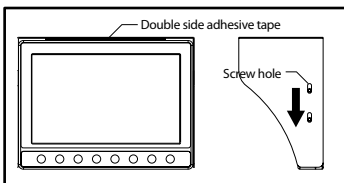

3. Sunvisor(option) should be installed with 4 screws.

* Ceiling mount stand(option)

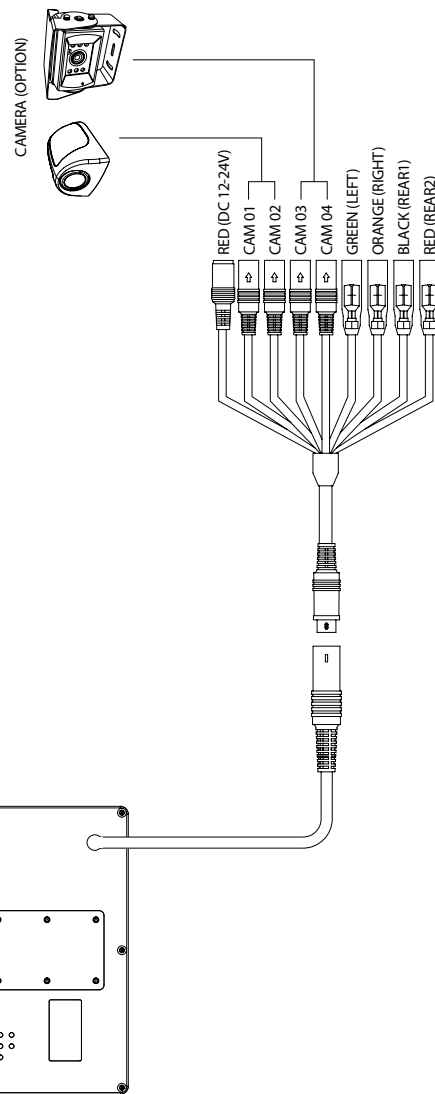
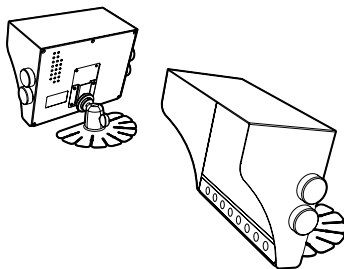
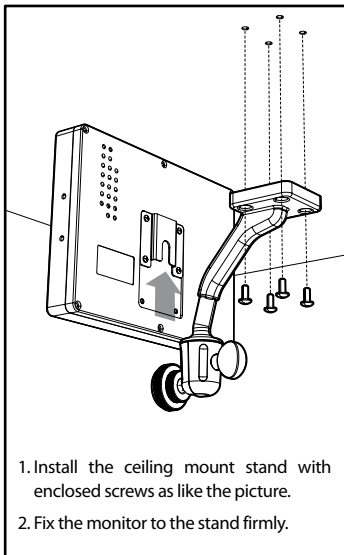

7

SPECIFICATION

7" WATERPROOF MONITOR

LCD Panel	Screen size	7 inch
	Resolution	WVGA (800x480)
	Brightness	250cd/m ²
	Constrast ratio	400:1
	View angle(L/R/U/D)	70° / 70° / 45° / 55°
Power Supply	Voltage	DC 12V ~ 24V
	Current	450mA (DC 12V, monitor set only)
Input System		NTSC / PAL
Frequency	NTSC	H : 15.734 kHz / V : 59.94 Hz
	PAL	H : 15.625 kHz / V : 50 Hz
Input Signal	Video Signal	Composite Video (CVBS)
	Audio Signal	MONO
Speaker		0.5Watt max.
Language display selection		ENGLISH - FRENCH - GERMAN - ITALIAN - SPANISH
User Controls (8 button)		Dimmer, Mode, Down, Up, Left, Right, Menu, Power
Operating temperature		-10°C ~ 60°C
Storage temperature		-20°C ~ 70°C
Dimension		180(W) x 133(H) x 27(D) mm
Weight		708g (monitor only)



NOTICE

In case of starting usage on low temperature than working temperature, the screen may blink for a while (2~5 minute). Please wait about 10 minutes and try to power on again.